

5-Line ESD Protection Diode Array in LLP75-6L

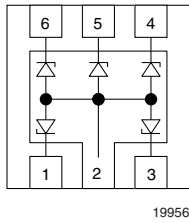

19956

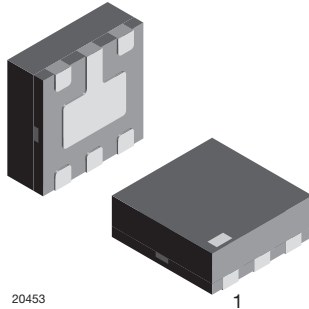

20453

1

MARKING (example only)

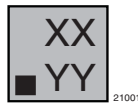

Dot = pin 1 marking

YY = type code (see table below)

XX = date code

DESIGN SUPPORT TOOLS

[click logo to get started](#)

FEATURES

- Ultra compact LLP75-6L package
- Low package profile < 0.6 mm
- 5-line ESD protection
- Surge immunity acc. IEC 61000-4-5 $I_{PPM} > 12$ A
- Low leakage current $I_R < 1$ μ A
- ESD immunity acc. IEC 61000-4-2
 ± 30 kV contact discharge
 ± 30 kV air discharge
- Working voltage range $V_{RWM} = 5$ V
- e4 - precious metal (e.g. Ag, Au, NiPd, NiPdAu) (no Sn)
- Material categorization: for definitions of compliance please see www.vishay.com/doc?99912

RoHS
 COMPLIANT
 HALOGEN
FREE
GREEN
 (5-2008)

ORDERING INFORMATION

DEVICE NAME	ORDERING CODE	TAPED UNITS PER REEL (8 mm TAPE ON 7" REEL)	MINIMUM ORDER QUANTITY
GMF05C-HSF	GMF05C-HSF-GS08	3000	15 000

PACKAGE DATA

DEVICE NAME	PACKAGE NAME	TYPE CODE	WEIGHT	MOLDING COMPOUND FLAMMABILITY RATING	MOISTURE SENSITIVITY LEVEL	SOLDERING CONDITIONS
GMF05C-HSF	LLP75-6L	1A	4.2 mg	UL 94 V-0	MSL level 1 (according J-STD-020)	Peak temperature max. 260 °C

ABSOLUTE MAXIMUM RATINGS GMF05C-HSF

PARAMETER	TEST CONDITIONS	SYMBOL	VALUE	UNIT
Peak pulse current	BiAs-mode: each input (pin 1; 3 - pin 6) to ground (pin 2); acc. IEC 61000-4-5; $t_p = 8/20$ μ s; single shot	I_{PPM}	12	A
Peak pulse power	BiAs-mode: each input (pin 1; 3 - pin 6) to ground (pin 2); acc. IEC 61000-4-5; $t_p = 8/20$ μ s; single shot	P_{PP}	200	W
ESD immunity	BiAs-mode: each input (pin 1; 3 - pin 6) to ground (pin 2); acc. IEC 61000-4-2; 10 pulses	Contact discharge	V_{ESD}	± 30 kV
		Air discharge	V_{ESD}	± 30 kV
Operating temperature	Junction temperature	T_J	-55 to +125	°C
Storage temperature		T_{STG}	-55 to +150	°C

BiAs-MODE (5-line bidirectional asymmetrical protection mode)

With the GMF05C-HSF up to 5 signal- or data-lines (L1 to L5) can be protected against voltage transients. With pin 2 connected to ground and pin 1; 3 up to pin 6 connected to a signal- or data-line which has to be protected. As long as the voltage level on the data- or signal-line is between 0 V (ground level) and the specified maximum reverse working voltage (V_{RWM}) the protection diode between data line and ground offer a high isolation to the ground line. The protection device behaves like an open switch. As soon as any positive transient voltage signal exceeds the break through voltage level of the protection diode, the diode becomes conductive and shorts the transient current to ground. Now the protection device behaves like a closed switch. The clamping voltage (V_C) is defined by the breakthrough voltage (V_{BR}) level plus the voltage drop at the series impedance (resistance and inductance) of the protection device.

Any negative transient signal will be clamped accordingly. The negative transient current is flowing in the forward direction of the protection diode. The low forward voltage (V_F) clamps the negative transient close to the ground level.

Due to the different clamping levels in forward and reverse direction the GMF05C-HSF clamping behavior is bidirectional and asymmetrical (BiAs).

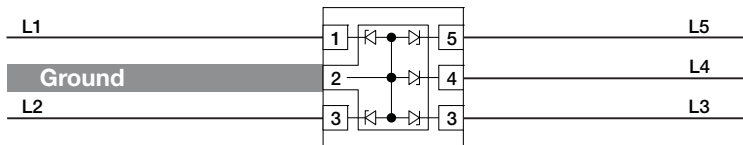

20739

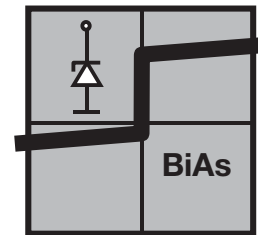

ELECTRICAL CHARACTERISTICS GMF05C-HSF						
PARAMETER	TEST CONDITIONS/REMARKS	SYMBOL	MIN.	TYP.	MAX.	UNIT
Protection paths	Number of lines which can be protected	$N_{channel}$	-	-	5	lines
Reverse stand-off voltage	Max. reverse working voltage	V_{RWM}	-	-	5	V
Reverse voltage	at $I_R = 1 \mu A$	V_R	5	-	-	V
Reverse current	at $V_R = V_{RWM} = 5 V$	I_R	-	< 0.1	1	μA
Reverse breakdown voltage	at $I_R = 1 mA$	V_{BR}	6	-	8	V
Reverse clamping voltage	at $I_{PP} = 12 A$ acc. IEC 61000-4-5	V_C	-	-	12.5	V
	at $I_{PP} = 1 A$ acc. IEC 61000-4-5		-	7.8	9.5	V
Forward clamping voltage	at $I_F = 12 A$ acc. IEC 61000-4-5	V_F	-	-	5.5	V
	at $I_{PP} = 1 A$ acc. IEC 61000-4-5		-	1.5	-	V
Capacitance	at $V_R = 0 V$; $f = 1 MHz$	C_D	-	126	150	pF
	at $V_R = 2.5 V$; $f = 1 MHz$		-	76	-	pF

Note

- Ratings at 25 °C, ambient temperature unless otherwise specified. BiAs mode: each input (pin 1; 3 - pin 6) to ground (pin 2)

If a higher surge current or peak pulse current (I_{PP}) is needed, some protection diodes in the GMF05C-HSF can also be used in parallel in order to “multiply” the performance.

If two diodes are switched in parallel you get

- double surge power = double peak pulse current ($2 \times I_{PPM}$)
- half of the line inductance = reduced clamping voltage
- half of the line resistance = reduced clamping voltage
- double line capacitance ($2 \times C_D$)
- double reverse leakage current ($2 \times I_R$)

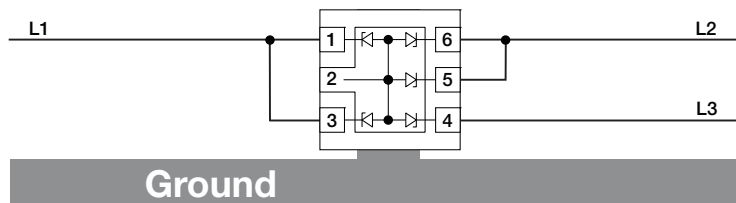

20740

TYPICAL CHARACTERISTICS ($T_{amb} = 25\text{ }^{\circ}\text{C}$, unless otherwise specified)

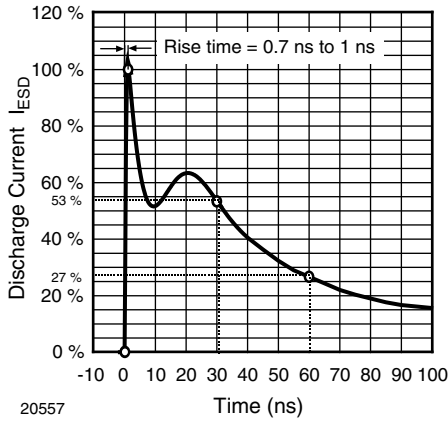

Fig. 1 - ESD Discharge Current Wave Form
acc. IEC 61000-4-2 (330 Ω /150 pF)

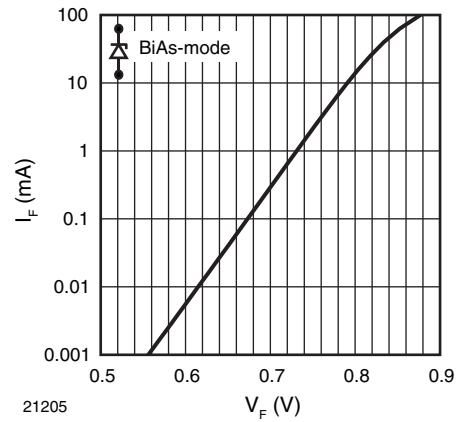

Fig. 4 - Typical Forward Current I_F vs. Forward Voltage V_F

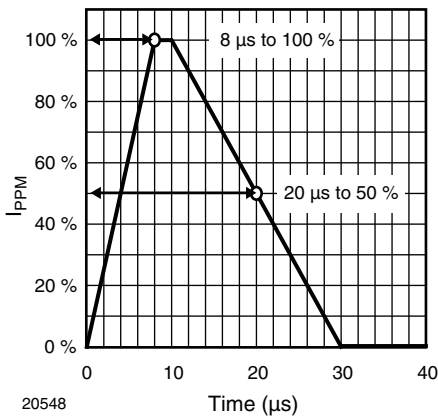

Fig. 2 - 8/20 μs Peak Pulse Current Wave Form
acc. IEC 61000-4-5

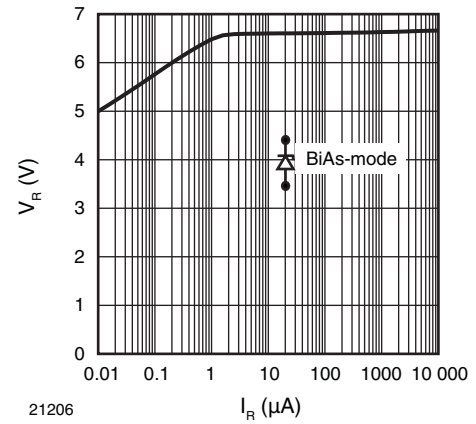

Fig. 5 - Typical Reverse Voltage V_R vs. Reverse Current I_R

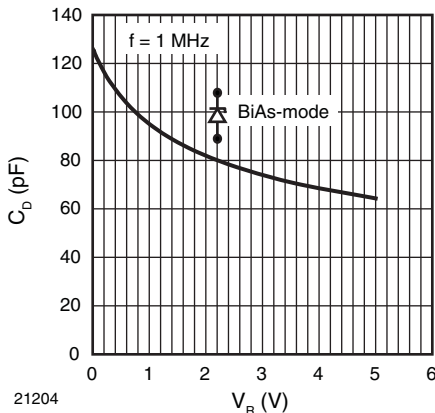

Fig. 3 - Typical Capacitance C_D vs. Reverse Voltage V_R

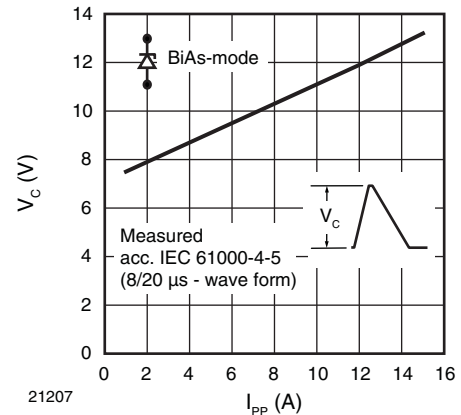

Fig. 6 - Typical Peak Clamping Voltage V_C vs. Peak Pulse Current I_{PP}

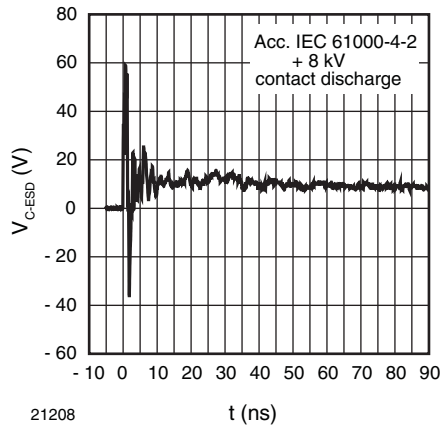

Fig. 7 - Typical Clamping Performance at + 8 kV Contact Discharge (acc. IEC 61000-4-2)

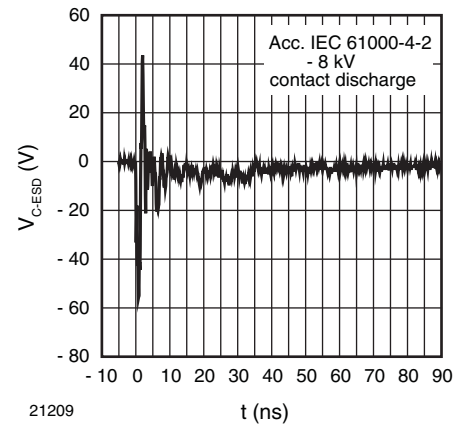

Fig. 8 - Typical Clamping Performance at - 8 kV Contact Discharge (acc. IEC 61000-4-2)

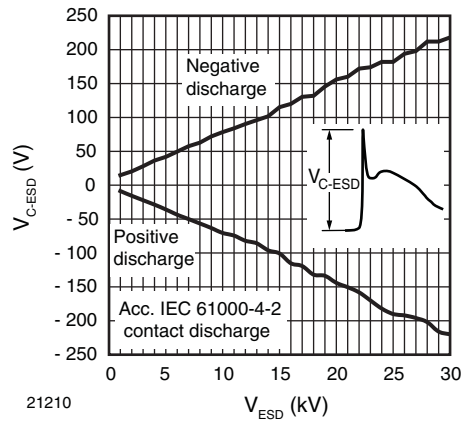
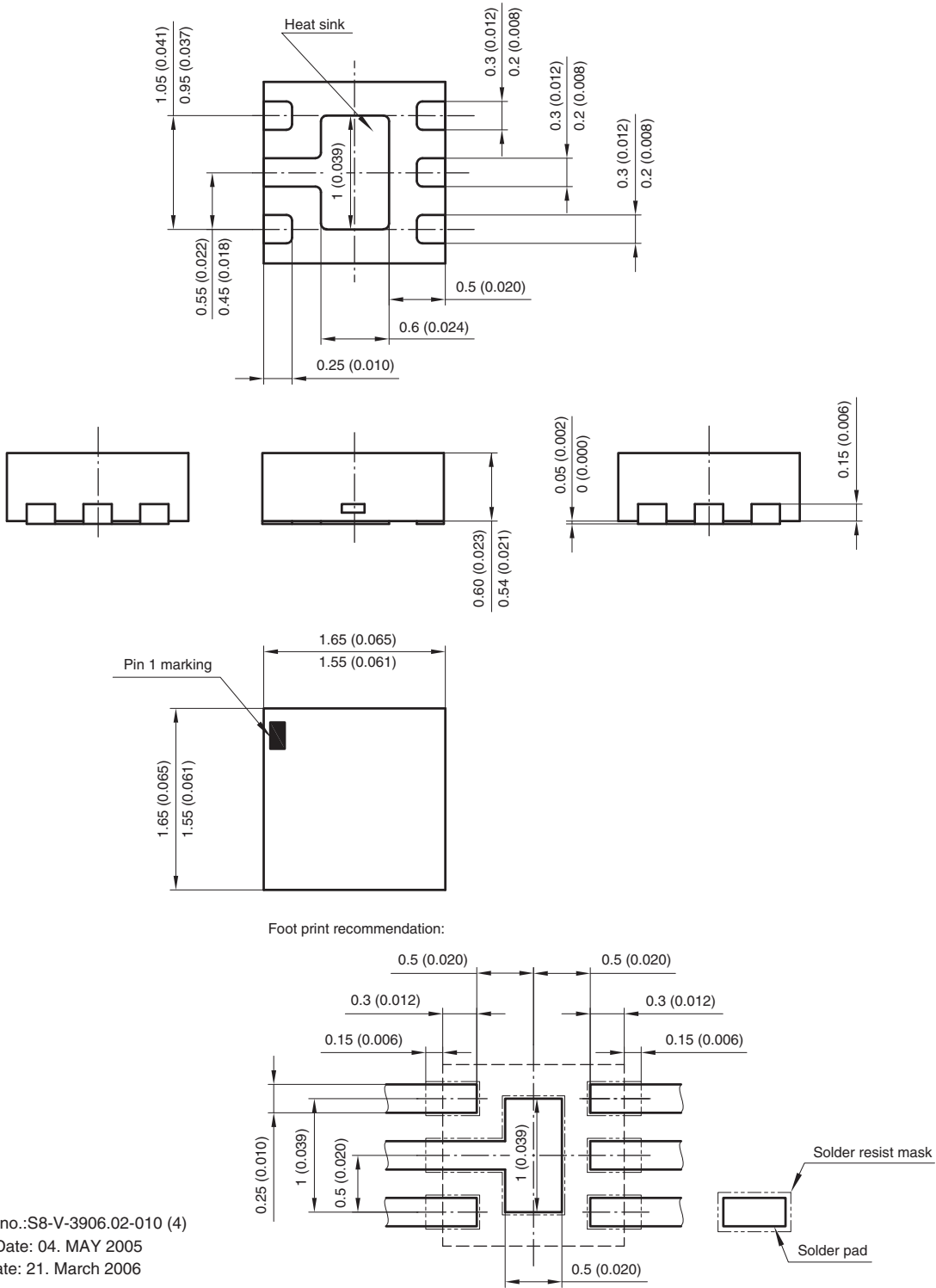

Fig. 9 - Typical Peak Clamping Voltage at ESD Contact Discharge (acc. IEC 61000-4-2)



PACKAGE DIMENSIONS in millimeters (Inches): **LLP75-6L**



Document no.:S8-V-3906.02-010 (4)
 Created - Date: 04. MAY 2005
 Rev. 4 - Date: 21. March 2006
 20454

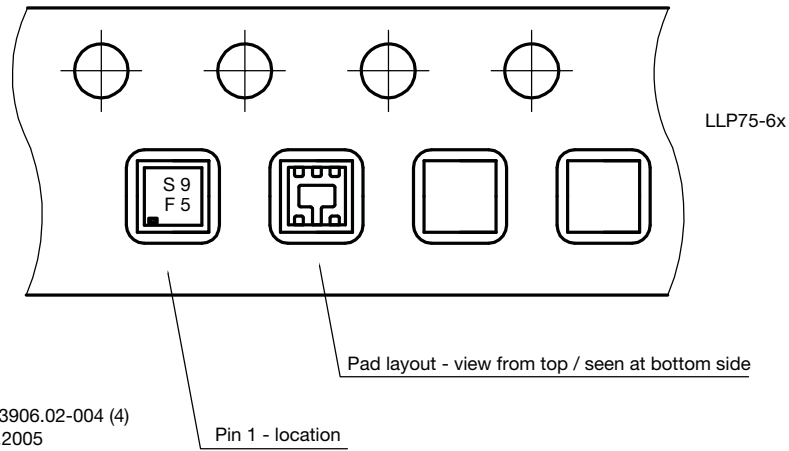

S8-V-3906.02-004 (4)
10.01.2005



Disclaimer

ALL PRODUCT, PRODUCT SPECIFICATIONS AND DATA ARE SUBJECT TO CHANGE WITHOUT NOTICE TO IMPROVE RELIABILITY, FUNCTION OR DESIGN OR OTHERWISE.

Vishay Intertechnology, Inc., its affiliates, agents, and employees, and all persons acting on its or their behalf (collectively, "Vishay"), disclaim any and all liability for any errors, inaccuracies or incompleteness contained in any datasheet or in any other disclosure relating to any product.

Vishay makes no warranty, representation or guarantee regarding the suitability of the products for any particular purpose or the continuing production of any product. To the maximum extent permitted by applicable law, Vishay disclaims (i) any and all liability arising out of the application or use of any product, (ii) any and all liability, including without limitation special, consequential or incidental damages, and (iii) any and all implied warranties, including warranties of fitness for particular purpose, non-infringement and merchantability.

Statements regarding the suitability of products for certain types of applications are based on Vishay's knowledge of typical requirements that are often placed on Vishay products in generic applications. Such statements are not binding statements about the suitability of products for a particular application. It is the customer's responsibility to validate that a particular product with the properties described in the product specification is suitable for use in a particular application. Parameters provided in datasheets and / or specifications may vary in different applications and performance may vary over time. All operating parameters, including typical parameters, must be validated for each customer application by the customer's technical experts. Product specifications do not expand or otherwise modify Vishay's terms and conditions of purchase, including but not limited to the warranty expressed therein.

Hyperlinks included in this datasheet may direct users to third-party websites. These links are provided as a convenience and for informational purposes only. Inclusion of these hyperlinks does not constitute an endorsement or an approval by Vishay of any of the products, services or opinions of the corporation, organization or individual associated with the third-party website. Vishay disclaims any and all liability and bears no responsibility for the accuracy, legality or content of the third-party website or for that of subsequent links.

Except as expressly indicated in writing, Vishay products are not designed for use in medical, life-saving, or life-sustaining applications or for any other application in which the failure of the Vishay product could result in personal injury or death. Customers using or selling Vishay products not expressly indicated for use in such applications do so at their own risk. Please contact authorized Vishay personnel to obtain written terms and conditions regarding products designed for such applications.

No license, express or implied, by estoppel or otherwise, to any intellectual property rights is granted by this document or by any conduct of Vishay. Product names and markings noted herein may be trademarks of their respective owners.